

RYOBI NATION

PLANS BY ANA WHITE

TABLE SAW CART



TOTAL DIMENSIONS: 24 X 36 X 40
DIFFICULTY LEVEL: INTERMEDIATE

MATERIAL LIST:

- (1) 48"x96" 3/4" plywood
- (1) 48"x48" 1/4" plywood
- (4) Locking caster wheels
(minimum 2-1/2" tall)
- (24) 1-1/4" coarse thread pocket
hole screws
- (50) 18 gauge brad nails

Wood glue

RECOMMENDED TOOLS:

- Table saw or circular saw
- Drill/driver
- Pocket Hole tool
- Pocket hole drill bit
- 18 gauge brad nailer

LUMBER CUT LIST

3/4" PLYWOOD



*HEIGHT OF CASTER WHEELS MUST BE AT LEAST 2-1/2" TALL

LUMBER CUT LIST:

1/4" PLYWOOD

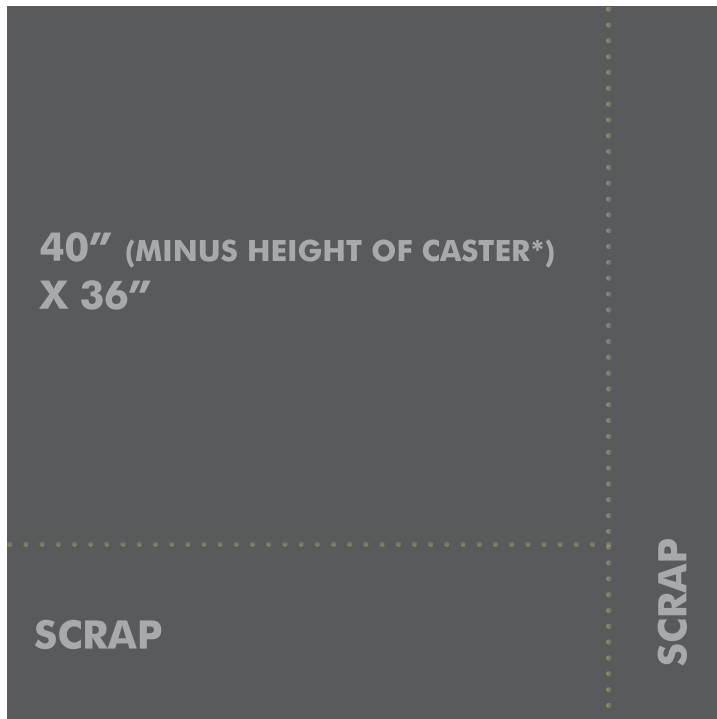

*HEIGHT OF CASTER WHEELS MUST BE AT LEAST 2-1/2" TALL

OPTIONAL DRAWERS:

1" x 6" boards (drawer front/side)
1/4" plywood (drawer bottoms)
Drawer slide hardware

*The amount of material needed varies according to the number/size of shelves/drawers.

OPTIONAL SHELVES:

(1) 24" x 18-7/8" 3/4" plywood per shelf



HELPFUL HINT

The Home Depot stores will make complimentary plywood cuts.

ASSEMBLY:

1

Rip 3/4" plywood into strips 24" wide by 8 feet long using either a table saw or circular saw.

2

Measure height of caster wheels and height of table saw deck. Subtract these measurements from 34-1/2". From the 24" wide strips, cut three pieces to this length.



3

Cut remaining pieces according to cut list.

ASSEMBLY:

4

Drill four 3/4" pocket holes on each end (measuring 24" long) of the side/divider pieces. Attach sides to top and bottom with 1-1/4" pocket hole screws.

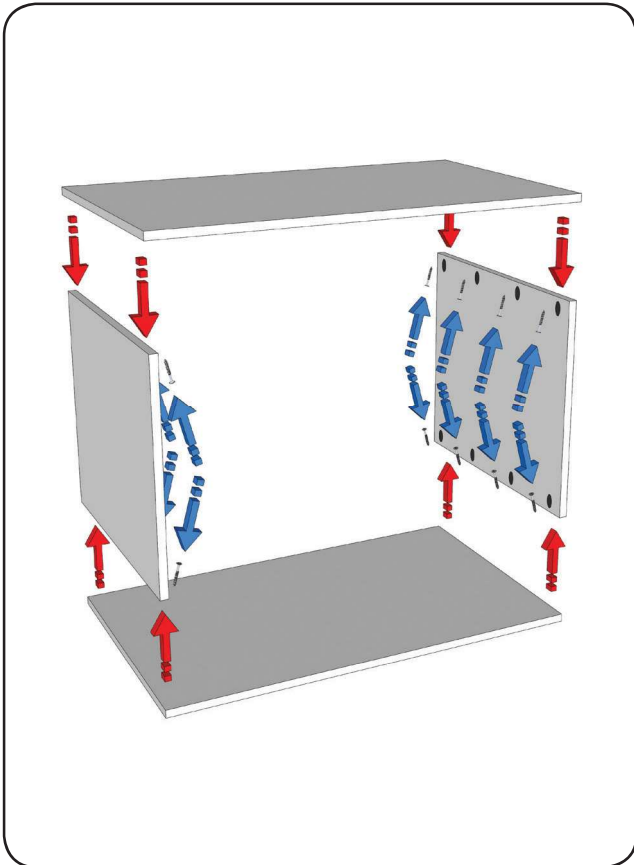

5

Mark center of top/bottom. Attach divider to top and bottom with 1-1/4" pocket hole screws.

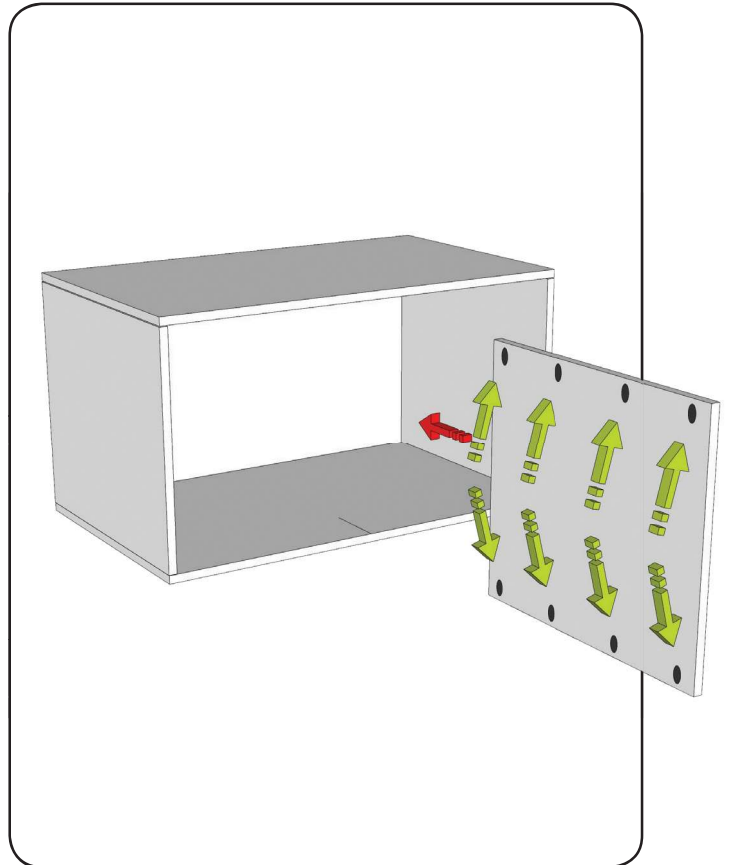

HELPFUL HINT

If adding shelves, when attaching divider, use the shelves as a guide to place the divider.

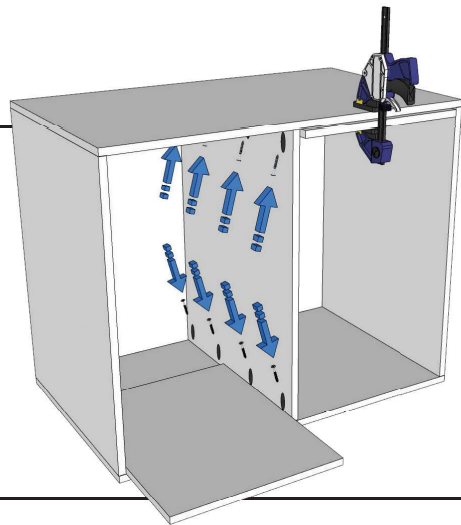

ASSEMBLY:

6

Apply glue to back edges of the cart.
Attach back with 3/4" brad nails.

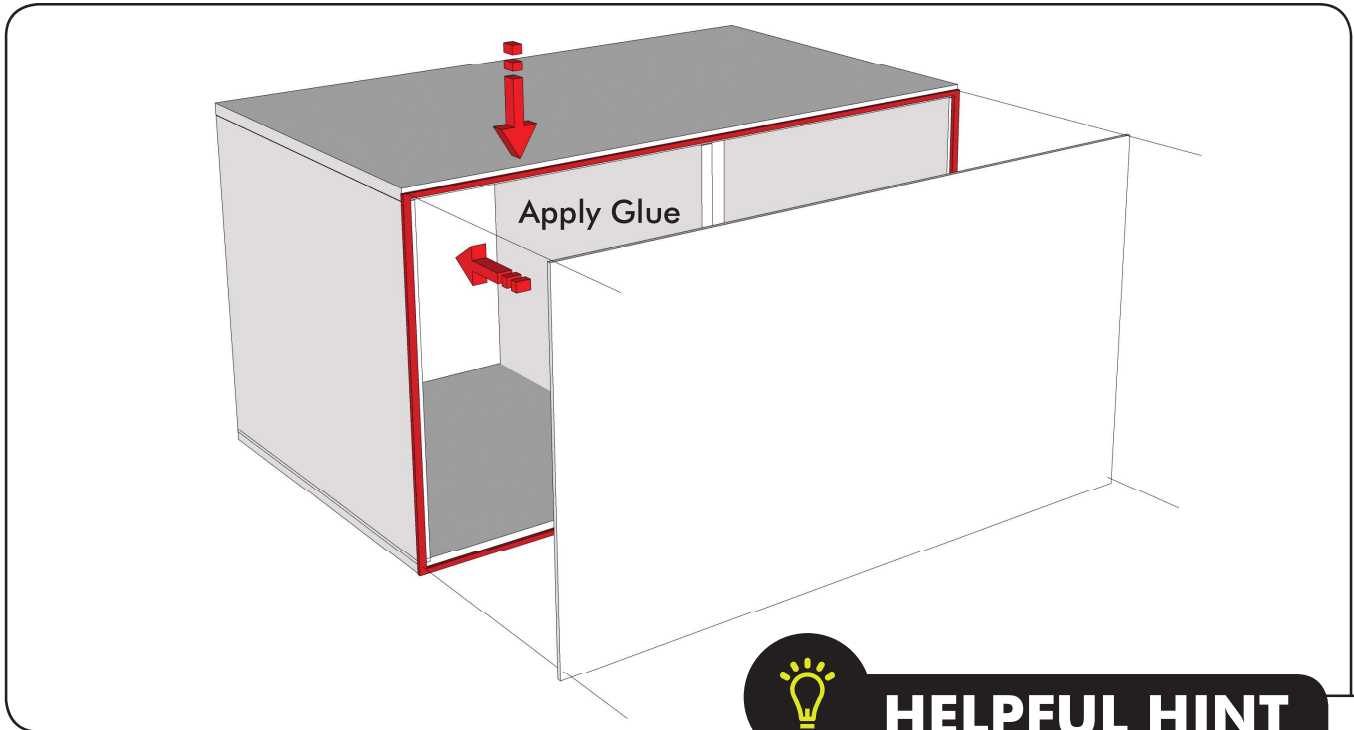

HELPFUL HINT

We used a total of 50 brad nails to ensure a strong fit to glued back.

7

Install caster wheels at base of cart.

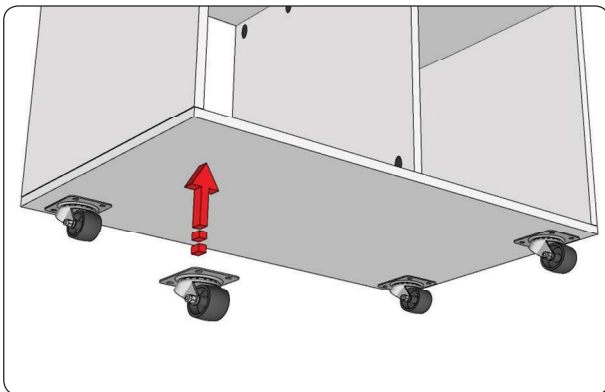

OPTIONAL DRAWERS:

8

Measure distance between side and divider and subtract 1".
Per drawer, cut two – 1x12 to this length (front and back of drawer).

Cut two 1x12 to 20-1/2" long per drawer (drawer sides). Drill three 3/4" pocket holes on each end of drawer sides. Attach drawer sides to drawer front/back with 1-1/4" pocket hole screws.

Measure bottom of drawer and cut 1/4" plywood to fit.
Use 3/4" brad nails and glue to attach.

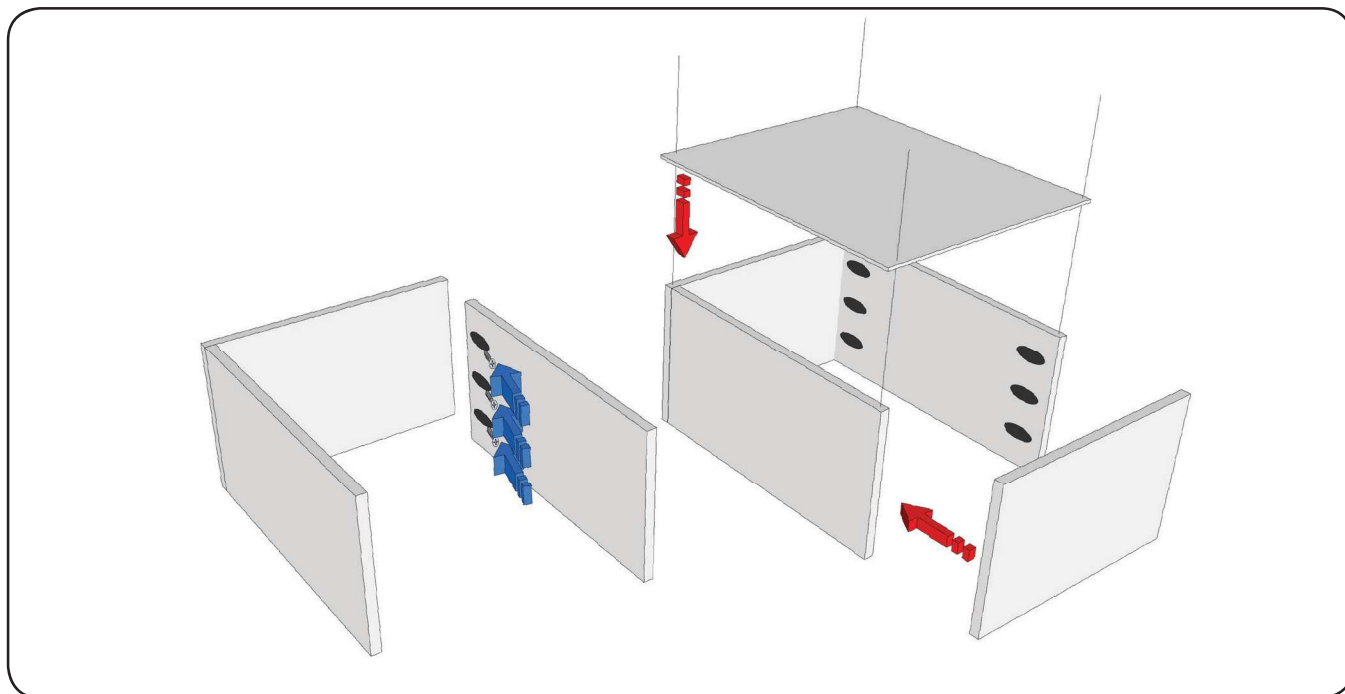

9

Install drawers with 22" drawer slides according to manufacturer's instructions.



HELPFUL HINT

Customize the number of drawers or the drawer depth for your storage needs.

